

CODIGO **19938, 19939, 19940, 19941**

DESCRIPCION: **ESCALERA STANDARD ASIMETRICO AISI-316**

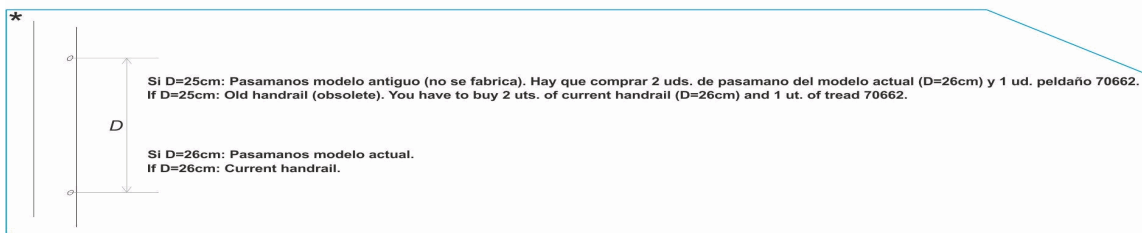
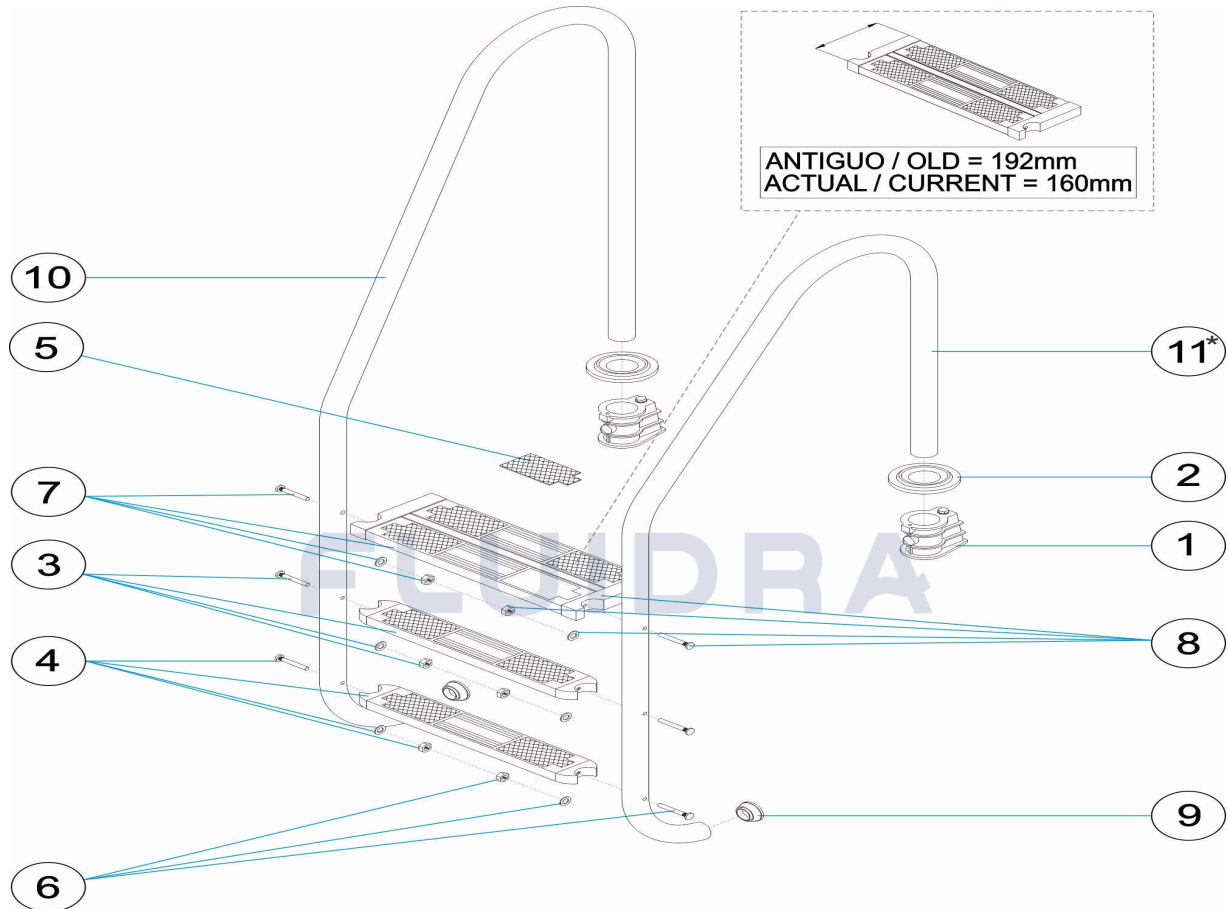

ESPAÑOL

POS	CODIGO	DESCRIPCION	CANTIDAD	POS	CODIGO	DESCRIPCION	CANTIDAD
1	44010101	ANCLAJE ESCALERA		9	4401010112	TOPE ESCALERA	
2	44010103	TAPETA EMBELLECEDORA 316		10	* 05476R0500	PASAMANO ASIMETRICO 2 PELDAÑOS	
3	44010104	PELDAÑO LUXE 316		10	* 05477R0500	PASAMANO ASIMETRICO 3 PELDAÑOS	
4	44010107	SOPORTE LATERAL PELDAÑO 316		10	* 05478R0500	PASAMANO ASIMETRICO 4 PELDAÑOS	
5	44010108	TAPETA PELDAÑO LUXE		10	* 05479R0500	PASAMANO ASIMETRICO 5 PELDAÑOS	
6	44010111	TORNILLERIA PELDAÑO 316		11	* 05476R0001	PASAMANO STANDARD 2 PELDAÑOS	
7	* 4401010805	PELDAÑO SEGURIDAD 316		11	* 05477R0001	PASAMANOS 3 PELDAÑOS AISI-316	
7	* 70662	PELDAÑO SEGURIDAD		11	* 05478R0001	PASAMANOS 4 PELDAÑOS AISI-316	
8	* 4401010807	SOPORTE LATERAL SEGURIDAD		11	* 05479R0001	PASAMANOS ESC. 5P. AISI 316	
8	* 4401010028	SOPORTE LATERAL SEGURIDAD					

CODIGO 19938, 19939, 19940, 19941

DESCRIPCION: ESCALERA STANDARD ASIMETRICO AISI-316

OBSERVACIONES

POS	CODIGO	OBSERVACIONES
7	* 4401010805	PARA: MIRAR COMENTARIOS * / SEE COMMENTS *
7	* 70662	PARA: MIRAR COMENTARIOS * / SEE COMMENTS *
8	* 4401010807	PARA: MODELO ANTIGUO / OLD MODEL
8	* 4401010028	PARA: MODELO ACTUAL / CURRENT MODEL
10	* 05476R0500	PARA: 19938 MIRAR COMENTARIOS * / SEE COMMENTS *
10	* 05477R0500	PARA: 19939 MIRAR COMENTARIOS * / SEE COMMENTS *
10	* 05478R0500	PARA: 19940 MIRAR COMENTARIOS * / SEE COMMENTS *
10	* 05479R0500	PARA: 19941 MIRAR COMENTARIOS * / SEE COMMENTS *
11	* 05476R0001	PARA: 19938 MIRAR COMENTARIOS * / SEE COMMENTS *
11	* 05477R0001	PARA: 19939 MIRAR COMENTARIOS * / SEE COMMENTS *
11	* 05478R0001	PARA: 19940 MIRAR COMENTARIOS * / SEE COMMENTS *
11	* 05479R0001	PARA: 19941 MIRAR COMENTARIOS * / SEE COMMENTS *

CODE 19938, 19939, 19940, 19941

DESCRIPTION: ÉCHELLE STANDARD ASYMÉTRIQUE AISI-316

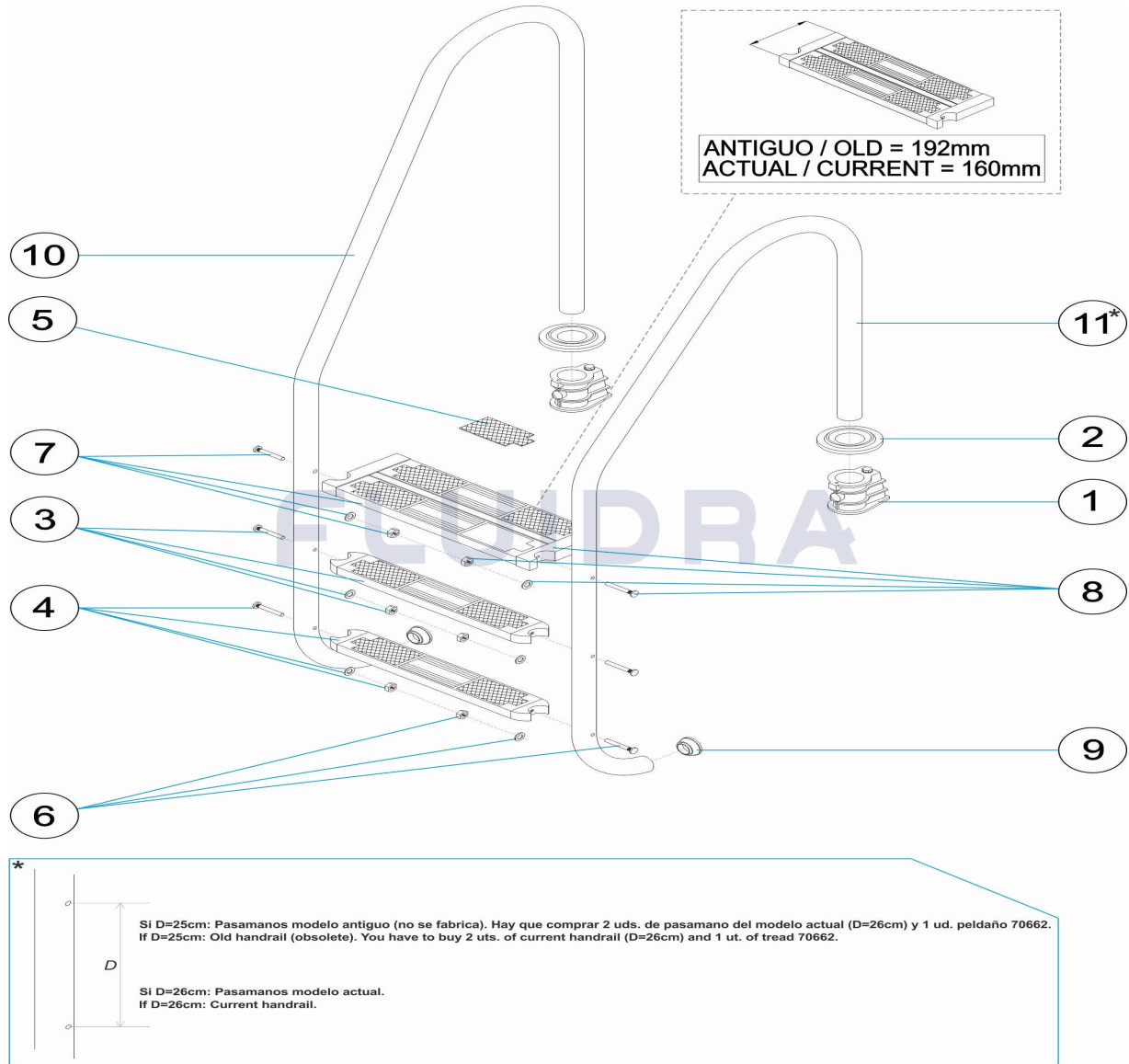

FRANCAIS

POS	CODE	DESCRIPTION	QUANTITE	POS	CODE	DESCRIPTION	QUANTITE
1	44010101	ANCORAGE D'ÉCHELLE		9	440101012	TAMPON D'ÉCHELLE	
2	44010103	ENJOLIVEUR AISI 316		10	* 05476R0500	MAIN COURANTE ASYMETRIQUE 2 MARCH	
3	44010104	MARCHE LUXE AISI 316		10	* 05477R0500	MAIN COURANTE ASYMETRIQUE 3 MARCH	
4	44010107	SUPPORT LATÉRAL DE MARCHE 316		10	* 05478R0500	MAIN COURANTE ASYMETRIQUE 4 MARCH	
5	44010108	PLAQUE NOIRE POUR MARCHE LUXE		10	* 05479R0500	MAIN COURANTE ASYMETRIQUE 5 MARCH	
6	44010111	VISSERIE MARCHE AISI 316		11	* 05476R0001	MAIN COURANTE ECHELLE 2 MARCHES AI	
7	* 4401010805	MARCHE DE SECURITE AISI 316		11	* 05477R0001	MAIN COURANTE ECHELLE 3 MARCHES AI	
7	* 70662	MARCHE DE SECURITE		11	* 05478R0001	MAIN COURANTE ECHELLE 4 MARCHES AI	
8	* 4401010807	SUPPORT LATERAL DE SECURITE		11	* 05479R0001	MAIN COURANTE ECHELLE 5 MARCHES AI	
8	* 4401010028	SUPPORT LATERAL DE SECURITE					

CODE **19938, 19939, 19940, 19941**

DESCRIPTION: **ÉCHELLE STANDARD ASYMÉTRIQUE AISI-316**

OBSERVATIONS

POS	CODE	OBSERVATIONS
7	* 4401010805	POUR: MIRAR COMENTARIOS * / SEE COMMENTS *
7	* 70662	POUR: MIRAR COMENTARIOS * / SEE COMMENTS *
8	* 4401010807	POUR: MODELO ANTIGUO / OLD MODEL
8	* 4401010028	POUR: MODELO ACTUAL / CURRENT MODEL
10	* 05476R0500	POUR: 19938 MIRAR COMENTARIOS * / SEE COMMENTS *
10	* 05477R0500	POUR: 19939 MIRAR COMENTARIOS * / SEE COMMENTS *
10	* 05478R0500	POUR: 19940 MIRAR COMENTARIOS * / SEE COMMENTS *
10	* 05479R0500	POUR: 19941 MIRAR COMENTARIOS * / SEE COMMENTS *
11	* 05476R0001	POUR: 19938 MIRAR COMENTARIOS * / SEE COMMENTS *
11	* 05477R0001	POUR: 19939 MIRAR COMENTARIOS * / SEE COMMENTS *
11	* 05478R0001	POUR: 19940 MIRAR COMENTARIOS * / SEE COMMENTS *
11	* 05479R0001	POUR: 19941 MIRAR COMENTARIOS * / SEE COMMENTS *

CODE **19938, 19939, 19940, 19941**

DESCRIPTION: **NONSYMMETRICAL STANDARD LADDER AISI-316**

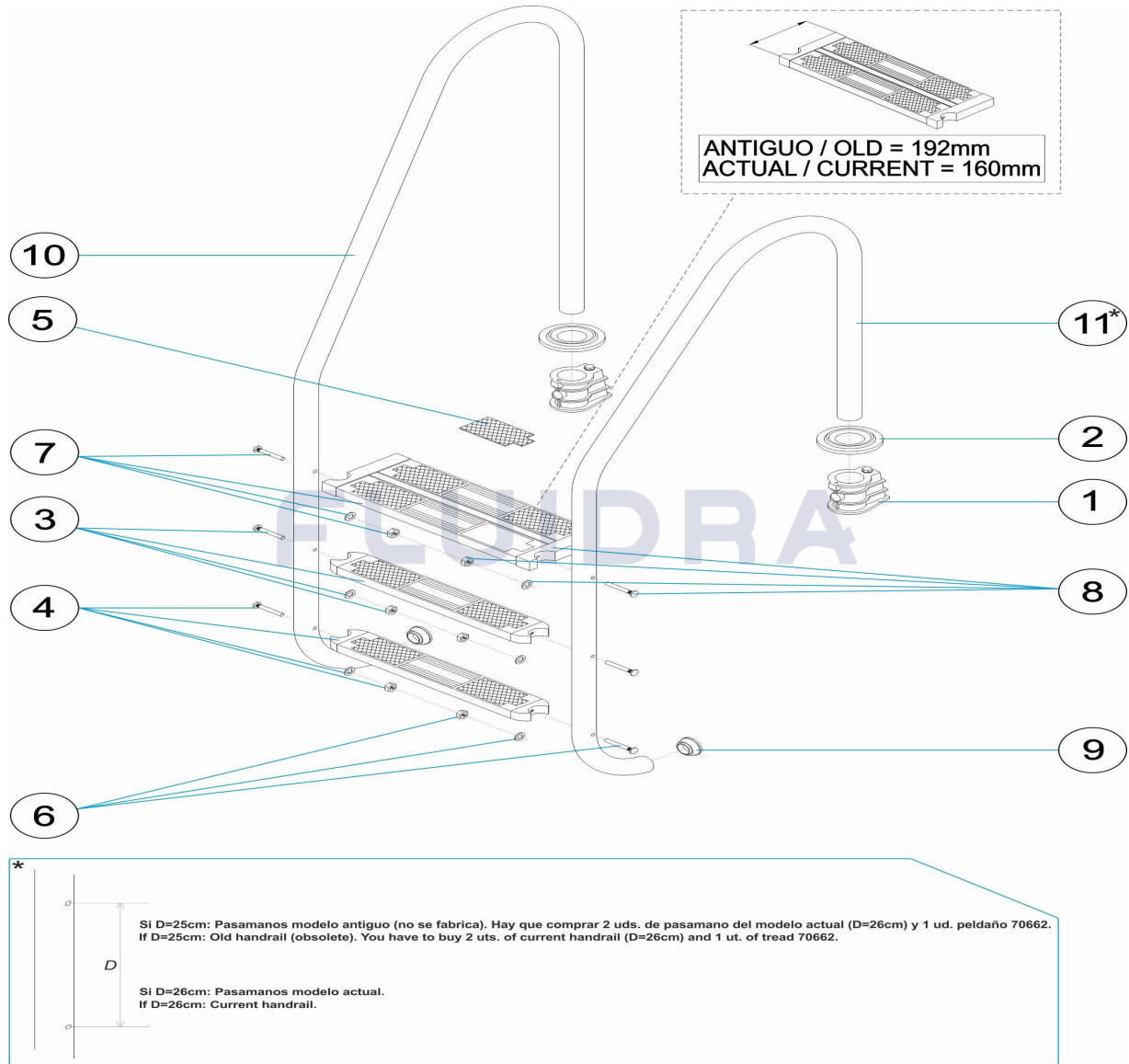

ENGLISH

POS	CODE	DESCRIPTION	QUANTITY	POS	CODE	DESCRIPTION	QUANTITY
1	44010101	LADDER ANCHOR		9	440101012	LADDER END CAP	
2	44010103	ESCUTCHEON 316		10	* 05476R0500	ASYMMETRIC HANDRAIL 2 STEPS	
3	44010104	DELUXE TREAD 316		10	* 05477R0500	ASYMMETRIC HANDRAIL 3 STEPS	
4	44010107	TREAD END SET 316		10	* 05478R0500	ASYMMETRIC HANDRAIL 4 STEPS	
5	44010108	DELUXE TREAD END INSERT		10	* 05479R0500	ASYMMETRIC HANDRAIL 5 STEPS	
6	44010111	TREAD BOLT SET 316		11	* 05476R0001	STANDARD HANDRAIL 2 STEPS	
7	* 4401010805	SAFETY TREAD 316		11	* 05477R0001	HANDRAIL 3 STEPS AISI-316	
7	* 70662	SAFETY TREAD		11	* 05478R0001	HANDRAIL 4 STEPS AISI-316	
8	* 4401010807	SAFETY TREAD END SET		11	* 05479R0001	HANDRAIL LADDER 5 STEPS AISI 316	
8	* 4401010028	SAFETY TREAD END SET					

CODE **19938, 19939, 19940, 19941**

DESCRIPTION: **NONSYMMETRICAL STANDARD LADDER AISI-316**

OBSERVATIONS

POS	CODE	OBSERVATIONS
7	* 4401010805	FOR: MIRAR COMENTARIOS * / SEE COMMENTS *
7	* 70662	FOR: MIRAR COMENTARIOS * / SEE COMMENTS *
8	* 4401010807	FOR: MODELO ANTIGUO / OLD MODEL
8	* 4401010028	FOR: MODELO ACTUAL / CURRENT MODEL
10	* 05476R0500	FOR: 19938 MIRAR COMENTARIOS * / SEE COMMENTS *
10	* 05477R0500	FOR: 19939 MIRAR COMENTARIOS * / SEE COMMENTS *
10	* 05478R0500	FOR: 19940 MIRAR COMENTARIOS * / SEE COMMENTS *
10	* 05479R0500	FOR: 19941 MIRAR COMENTARIOS * / SEE COMMENTS *
11	* 05476R0001	FOR: 19938 MIRAR COMENTARIOS * / SEE COMMENTS *
11	* 05477R0001	FOR: 19939 MIRAR COMENTARIOS * / SEE COMMENTS *
11	* 05478R0001	FOR: 19940 MIRAR COMENTARIOS * / SEE COMMENTS *
11	* 05479R0001	FOR: 19941 MIRAR COMENTARIOS * / SEE COMMENTS *

CODICE 19938, 19939, 19940, 19941

DESCRIZIONE: SCALA STANDARD ASIMMETRICA AISI-316

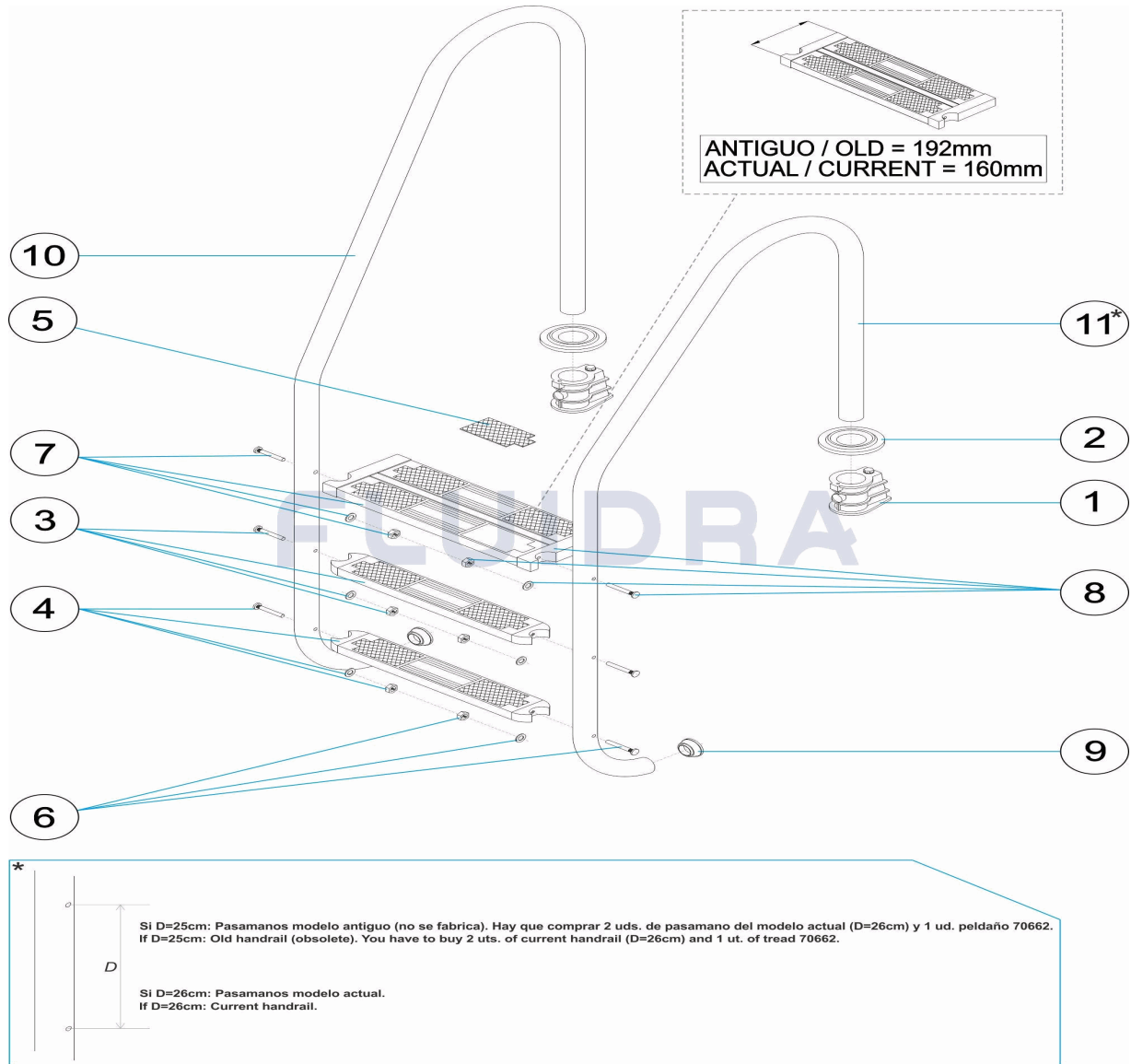

ITALIANO

POS	CODICE	DESCRIZIONE	QUANTITA'	POS	CODICE	DESCRIZIONE	QUANTITA'
1	44010101	ANCORAGGIO SCALA		9	440101012	TAPPO SCALA	
2	44010103	COPRIFLANGIA ANCORAGGIO AISI 316		10	* 05476R0500	CORRIMANO ASIMMETRICO 2 GRADINI	
3	44010104	GRADINO LUXE AISI 316		10	* 05477R0500	CORRIMANO ASIMMETRICO 3 GRADINI	
4	44010107	SOSTEGNO LATERALE GRADINO 316		10	* 05478R0500	CORRIMANO ASIMMETRICO 4 GRADINI	
5	44010108	TAPPETINO FINITURA GRADINO LUXE		10	* 05479R0500	CORRIMANO ASIMMETRICO 5 PELDÑOS	
6	44010111	BULLONERIA GRADINO AISI 316		11	* 05476R0001	CORRIMANO STANDARD 2 GRADINI	
7	* 44010805	GRADINO DI SICUREZZA AISI 316		11	* 05477R0001	CORRIMANO 3 GRADINI AISI-316	
7	* 70662	GRADINO DI SICUREZZA		11	* 05478R0001	CORRIMANO 4 GRADINI AISI-316	
8	* 44010807	SUPPORTO LATERALE SICUREZZA		11	* 05479R0001	CORRIMANO SCALA 5 GRADINI AISI 316	
8	* 44010028	SUPPORTO LATERALE SICUREZZA					

CODICE **19938, 19939, 19940, 19941**

DESCRIZIONE: **SCALA STANDARD ASIMMETRICA AISI-316**

OSSERVAZIONI

POS	CODICE	OSSERVAZIONI
7	* 4401010805	PER: MIRAR COMENTARIOS * / SEE COMMENTS *
7	* 70662	PER: MIRAR COMENTARIOS * / SEE COMMENTS *
8	* 4401010807	PER: MODELO ANTIGUO / OLD MODEL
8	* 4401010028	PER: MODELO ACTUAL / CURRENT MODEL
10	* 05476R0500	PER: 19938 MIRAR COMENTARIOS * / SEE COMMENTS *
10	* 05477R0500	PER: 19939 MIRAR COMENTARIOS * / SEE COMMENTS *
10	* 05478R0500	PER: 19940 MIRAR COMENTARIOS * / SEE COMMENTS *
10	* 05479R0500	PER: 19941 MIRAR COMENTARIOS * / SEE COMMENTS *
11	* 05476R0001	PER: 19938 MIRAR COMENTARIOS * / SEE COMMENTS *
11	* 05477R0001	PER: 19939 MIRAR COMENTARIOS * / SEE COMMENTS *
11	* 05478R0001	PER: 19940 MIRAR COMENTARIOS * / SEE COMMENTS *
11	* 05479R0001	PER: 19941 MIRAR COMENTARIOS * / SEE COMMENTS *

CODE **19938, 19939, 19940, 19941**

BESCHREIBUNG: **TREPPE STANDARD ASYMMETRISCH AISI-316**

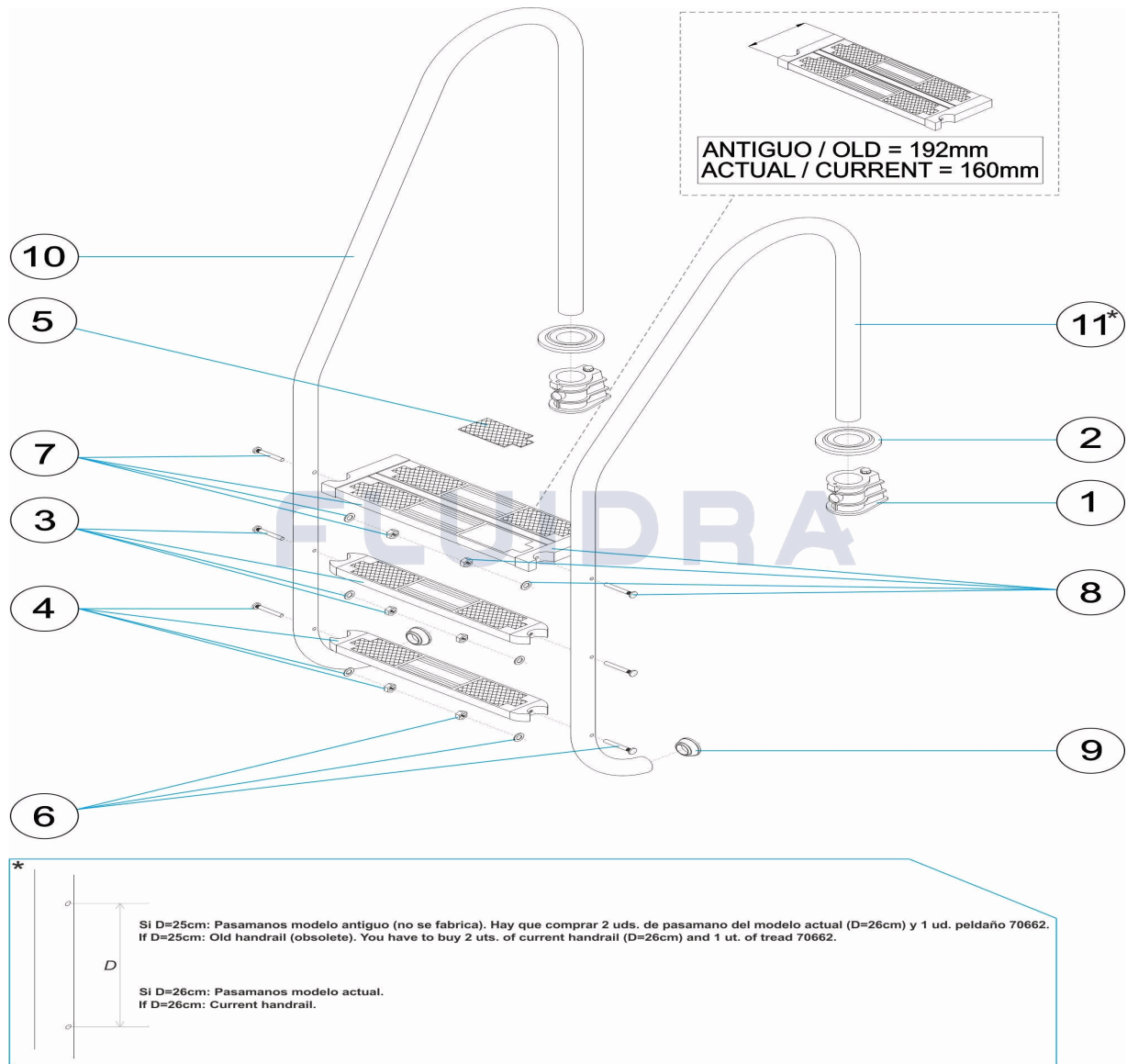

DEUTSCH

POS	CODE	BESCHREIBUNG	MENGE	POS	CODE	BESCHREIBUNG	MENGE
1	44010101	EINBAUHÜLSE		9	4401010112	ABSCHLUSS TREPPE	
2	44010103	DEKO-ABSCHLUSSRING 316		10	* 05476R0500	HANDLAUF ASYMMETRISCH 2 STUFEN	
3	44010104	STUFE LUXE 316		10	* 05477R0500	HANDLAUF ASYMMETRISCH 3 STUFEN	
4	44010107	SEITENHALTERUNG STUFE 316		10	* 05478R0500	HANDLAUF ASYMMETRISCH 4 STUFEN	
5	44010108	ABSCHLUSSPLATTE STUFE LUXE		10	* 05479R0500	HANDLAUF ASYMMETRISCH 5 STUFEN	
6	44010111	SCHRAUBENSATZ STUFE 316		11	* 05476R0001	HANDLAUF STANDARD 2 STUFEN	
7	* 4401010805	SICHERHEITSSTUFE 316		11	* 05477R0001	HANDLAUF 3 STUFEN AISI - 316	
7	* 70662	SICHERHEITSSTUFE		11	* 05478R0001	HANDLAUF 4 STUFEN AISI - 316	
8	* 4401010807	SICHERHEITSHALTERUNG SEITLICH		11	* 05479R0001	HANDLAUF TREPPE 5 STUFEN AISI 316	
8	* 4401010028	SICHERHEITSHALTERUNG SEITLICH					

CODE **19938, 19939, 19940, 19941**

BESCHREIBUNG: **TREPPE STANDARD ASYMMETRISCH AISI-316**

HINWEISE

POS	CODE	HINWEISE
7	* 4401010805	FÜR: MIRAR COMENTARIOS * / SEE COMMENTS *
7	* 70662	FÜR: MIRAR COMENTARIOS * / SEE COMMENTS *
8	* 4401010807	FÜR: MODELO ANTIGUO / OLD MODEL
8	* 4401010028	FÜR: MODELO ACTUAL / CURRENT MODEL
10	* 05476R0500	FÜR: 19938 MIRAR COMENTARIOS * / SEE COMMENTS *
10	* 05477R0500	FÜR: 19939 MIRAR COMENTARIOS * / SEE COMMENTS *
10	* 05478R0500	FÜR: 19940 MIRAR COMENTARIOS * / SEE COMMENTS *
10	* 05479R0500	FÜR: 19941 MIRAR COMENTARIOS * / SEE COMMENTS *
11	* 05476R0001	FÜR: 19938 MIRAR COMENTARIOS * / SEE COMMENTS *
11	* 05477R0001	FÜR: 19939 MIRAR COMENTARIOS * / SEE COMMENTS *
11	* 05478R0001	FÜR: 19940 MIRAR COMENTARIOS * / SEE COMMENTS *
11	* 05479R0001	FÜR: 19941 MIRAR COMENTARIOS * / SEE COMMENTS *

CODIGO 19938, 19939, 19940, 19941

DESCRICAÇÃO: ESCADA STANDARD ASSIMÉTRICA AISI-316

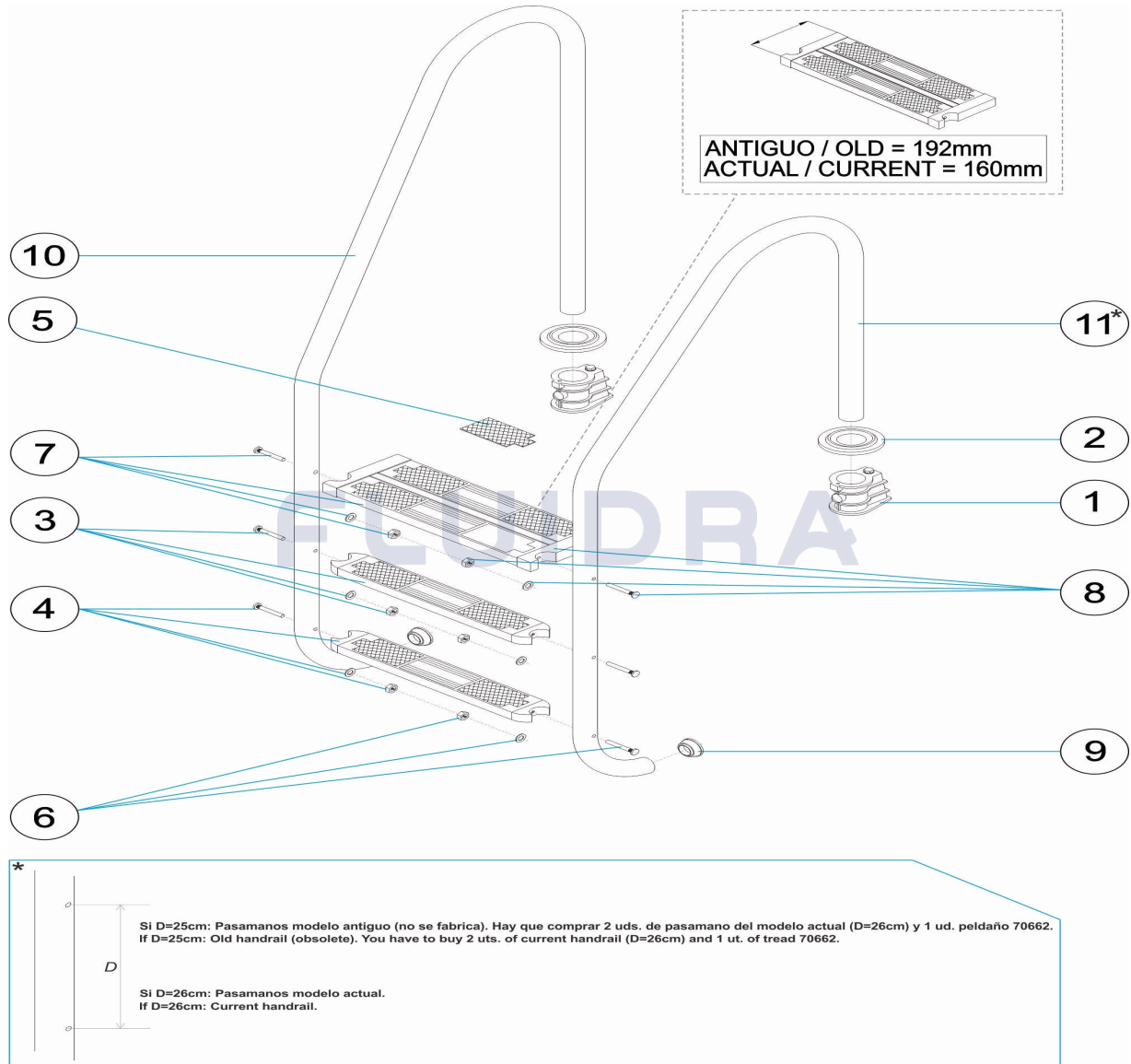

PORTUGUES

POS	CODIGO	DESCRICAÇÃO	JANTIDADE	POS	CODIGO	DESCRICAÇÃO	JANTIDADE
1	44010101	ÂNCORA		9	440101012	BATENTE ESCADA	
2	44010103	ESPELHO 316		10	* 05476R0500	CORRIMÃO ASSIMÉTRICO 2 DEGRAUS	
3	44010104	DEGRAU LUXE 316		10	* 05477R0500	CORRIMÃO ASSIMÉTRICO 3 DEGRAUS	
4	44010107	SUPORTE LATERAL DEGRAU 316		10	* 05478R0500	CORRIMÃO ASSIMÉTRICO 4 DEGRAUS	
5	44010108	ANTI DERRAPANTE DEGRAU LUXE		10	* 05479R0500	CORRIMÃO ASSIMÉTRICO 5 DEGRAUS	
6	44010111	PARAFUSOS DEGRAU 316		11	* 05476R0001	CORRIMÃO STANDARD 2 DEGRAUS	
7	* 4401010805	DEGRAU SEGURANÇA 316		11	* 05477R0001	CORRIMÃO 3 DEGRAUS AISI-316	
7	* 70662	DEGRAU SEGURANÇA		11	* 05478R0001	CORRIMÃO 4 DEGRAUS AISI-316	
8	* 4401010807	SUPORTE LATERAL SEGURANÇA		11	* 05479R0001	CORRIMÃO ESC. 5 D. AISI 316	
8	* 4401010028	SUPORTE LATERAL SEGURANÇA					

CODIGO **19938, 19939, 19940, 19941**

DESCRIÇÃO: ESCADA STANDARD ASSIMÉTRICA AISI-316

OBSERVAÇÕES

POS	CODIGO	OBSERVAÇÕES
7	* 4401010805	PARA: MIRAR COMENTARIOS * / SEE COMMENTS *
7	* 70662	PARA: MIRAR COMENTARIOS * / SEE COMMENTS *
8	* 4401010807	PARA: MODELO ANTIGUO / OLD MODEL
8	* 4401010028	PARA: MODELO ACTUAL / CURRENT MODEL
10	* 05476R0500	PARA: 19938 MIRAR COMENTARIOS * / SEE COMMENTS *
10	* 05477R0500	PARA: 19939 MIRAR COMENTARIOS * / SEE COMMENTS *
10	* 05478R0500	PARA: 19940 MIRAR COMENTARIOS * / SEE COMMENTS *
10	* 05479R0500	PARA: 19941 MIRAR COMENTARIOS * / SEE COMMENTS *
11	* 05476R0001	PARA: 19938 MIRAR COMENTARIOS * / SEE COMMENTS *
11	* 05477R0001	PARA: 19939 MIRAR COMENTARIOS * / SEE COMMENTS *
11	* 05478R0001	PARA: 19940 MIRAR COMENTARIOS * / SEE COMMENTS *
11	* 05479R0001	PARA: 19941 MIRAR COMENTARIOS * / SEE COMMENTS *